

2-finger parallel gripper - pneumatic - series OPP2 2-Finger - Parallelgreifer pneumatisch - Typ OPP2

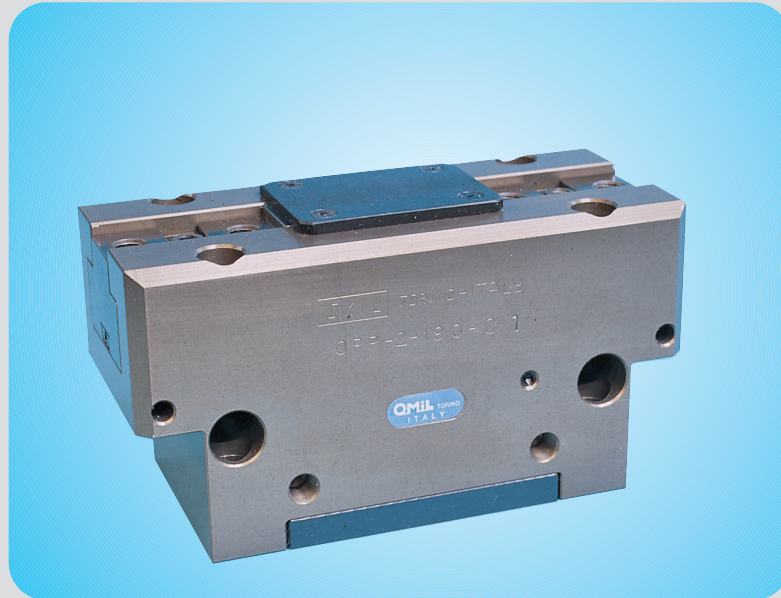

Technische Eigenschaften:

- Betriebsdruck: 2 bis 8 bar
- Wiederholgenauigkeit:
OPP2-64...125 0.01mm;
OPP2-160...320 0.02mm über 100
Schaltspiele
- Betriebstemperaturbereich:
von -10°C bis 90°C;
bis 130°C und höher auf Anfrage
- Kinematik: Keilhakenprinzip
zwangsgeführt über schräge Ebene
- Material : Gehäuse aus hochfester
Aluminiumlegierung hartbeschichtet,
Funktionsteile aus gehärtetem Stahl
- Betätigung : pneumatisch über gefilterte
Druckluft 10µm, trocken oder geölt
- Wartungsfrei: bis 1.5 Mio. Schaltspiele
- Für Innen-und Außengreifen geeignet
- Diagramm der empfohlenen Hebel und
Fingerlängen Seite 17
- Anschlussmaße der Grundbacken Seite 18
- Schutzart IP40
- Druckluftanschlüsse: über die
Seitenflächen-Grundflächen
- M5 Sperrluftanschluss möglich
- 24 Monate Garantie

Technical data:

- Range of operating pressure: 2 - 8 bar
- Repeatability accuracy:
OPP2- 64 .. 125 0.01 mm;
OPP2 - 160..320 0.02mm over 100
cycles
- Operating temperature: from -10°C to
90°C; version up to 130°C upon request
- Operating principle: wedge-hook
kinematics
- Housing material: high tensile hard-
coated aluminium alloy, hard-anodized
- Material of functional parts: treated
ground steel
- Actuation : compressed air filtered (10
µm), dry or lubricated
- Maintenance: no maintenance required
for the first 1.5 million cycles
- Suitable for internal/external gripping
- Maximum permitted finger offset page 17
- Layout finger connection page 18
- Rating IP 40
- Air connections: sides and base
- M5 pressurisation on both sides
- Warranty 24 months

2-finger parallel gripper - pneumatic - series OPP2

2-Finger - Parallelgreifer pneumatisch - Typ OPP2

Magnetic limit switch seat
type D-M9P (SMC) or R626 (OMIL)

Hubabfrage über
Magnetschalter Typ D-M9P
(SMC) oder R626 (OMIL)

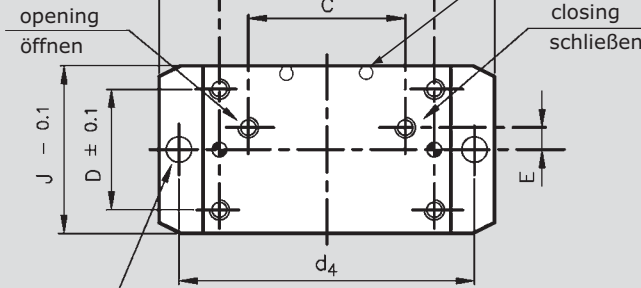

Hose-free direct
connection page 23

Maße für schlauchlosen
Direktanschluss seite 23

Bush for proximity AA

Bohrung für
Näherungsschalter ØAA

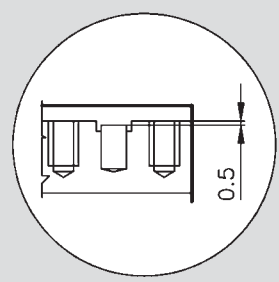
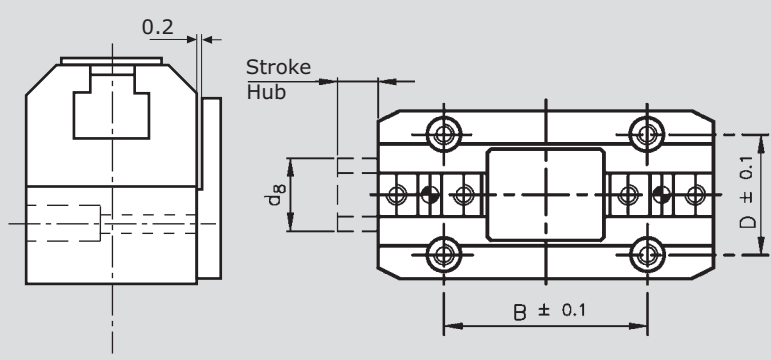
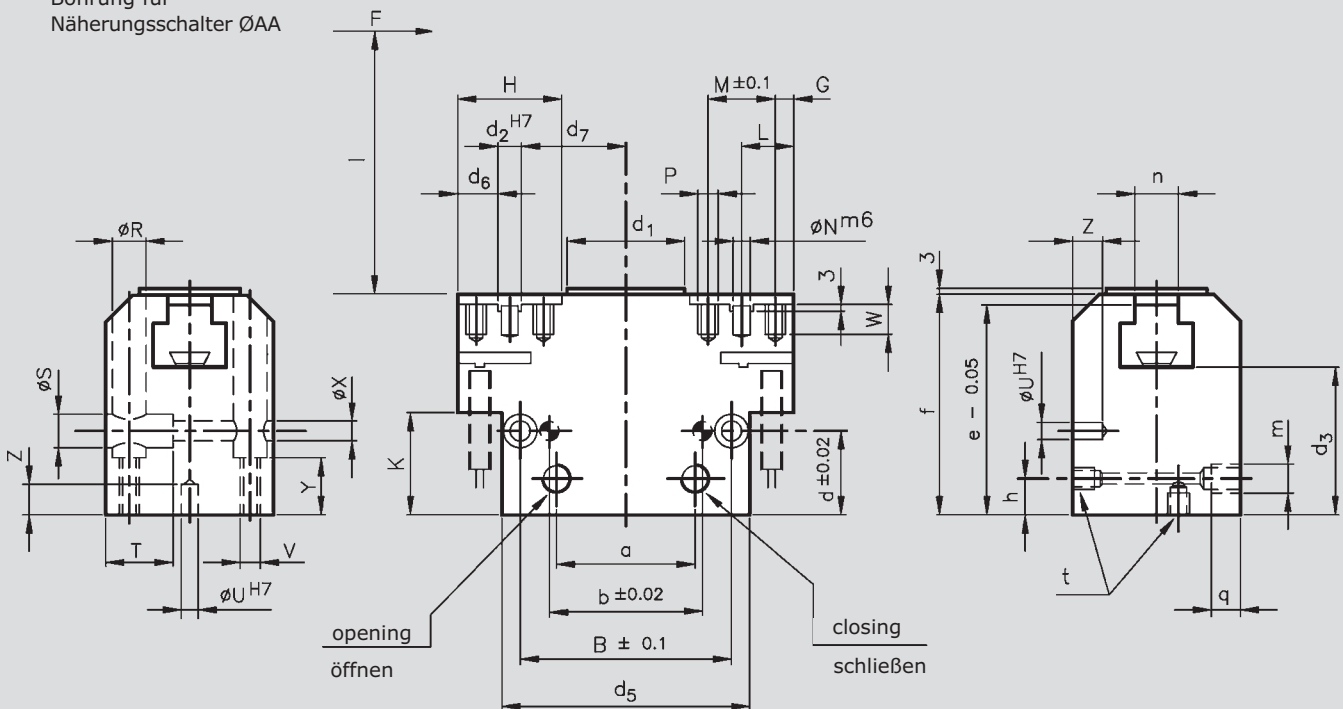

2-finger parallel gripper - pneumatic - series OPP2

2-Finger - Parallelgreifer pneumatisch - Typ OPP2

Type	A	B	C	D	E	G	H	J	L	M	N	P	R	S	T	U	V	Z	Y	X	K	W	a	
Typ																								
OPP2 64	64	43	28	28	8	4	21	38	10.5	13	4	M4	7.5	7.5	12	4	M5	5	14.5	4.5	18	6.5	30	
OPP2 80	80	53	36	34	9	5	25.5	44	13	16	5	M5	7.5	9	15	4	M5	8	13	5.5	23	8	39	
OPP2 100	100	67	44	40	13	6	32	52	16	20	6	M6	9.5	11	18	5	M6	8	21	6.5	27	10	48	
OPP2 125	125	81	56	46	14	8.5	40.5	62	20.5	24	6	M8	11	14	25	6	M8	10	22	9	33	12	60	
OPP2 160	160	102	70	58	12	9	50	74	25	32	8	M10	11	14	35	6	M8	10	21	9	36	13	76	
OPP2 180	180	120	76	60	14	9.5	55	80	27.5	36	10	M10	14	17	45	8	M10	10	27	11	45	16	80	
OPP2 200	200	130	86	68	20	11	62	90	31	40	12	M12	17	19	50	10	M12	12	33	13	50	20	90	
OPP2 250	250	164	112	90	28	17	80	120	41	48	12	M12	19	25	65	12	M16	18	45	17	63	22	118	
OPP2 320	320	200	140	112	24	18	100	144	50	64	16	M16	19	25	82	12	M16	20	36	17	66	26	132	

Type	b	d	d ₁	d ₂	d ₃	d ₄	d ₅	d ₆	d ₇	d ₈	e	f	h	l	m	n	q	t	AA	Stroke for finger (mm) code1 code2		
Typ																					Hub pro Finger (mm) Ver.1 Ver.2	
OPP2 64	22	19	21	5	24.5	55	52	8	19	18	37	39	11	23	M5	11	5	M3	Ø5	M5	6	3
OPP2 80	39	21	29	6	32	69	64	10	24	21	46	49	11	28	M5	13	6	M5	Ø6.5	M8	8	4
OPP2 100	48	26	34	8	34	88	80	12	30	25	52	55	15	34	1/8	15	7	M5	Ø6.5	M8	10	5
OPP2 125	58	31	43	8	40	111	100	16.5	38	32	60	64	16	38	1/8	18	7	M5	Ø6.5	M8	13	6.5
OPP2 160	78	30	56	10	47	144	125	20	50	40	73	77	19	45	1/8	22	8	M5	Ø6.5	M8	16	8
OPP2 180	80	40	66	12	57	160	140	21.5	56.5	45	91	95	20	50	1/8	26	8	M5	M8	M12	20	10
OPP2 200	90	50	74	14	67	180	156	24	62	48	108	112	22	55	1/8	30	10	M5	M8	M12	25	12.5
OPP2 250	124	60	88	16	83	224	200	33	76	56	131	139	31	60	1/8	36	10	M5	M8	M12	30	15
OPP2 320	152	50	118	20	113	292	250	40	100	68	162	170	36	65	1/4	44	10	M5	M8	M12	36	18

Type	Gripping force at 6 bar (N) code 1 code 2		Air consum for double stroke (cm ³)	Moment of inertia (Kgcm ²)	Gripper weight (Kg)	Recommended weight of part for transport (Kg) code 1 code 2		Approx. time (s) open close		Max finger length/weight
Typ	Greifkraft bei 6 bar (N) Vers. 1 Vers. 2		Luftverbrauch pro Doppelhub (cm ³)	Massenträgheitsmoment (Kgcm ²)	Masse (Kg)	Max. empfohlenes Werkstückgewicht (Kg) Vers. 1 Vers. 2		Schließzeit (s) öffnen schließen		Max. Fingerlänge/Eigenmasse
OPP2 64	220	420	9	1	0.27	1.1	2.1	0.02	0.02	64/0.32
OPP2 80	360	540	19	2.3	0.45	1.8	2.7	0.03	0.03	80/0.55
OPP2 100	550	900	39	6.4	0.8	2.7	4.5	0.05	0.05	100/1.05
OPP2 125	845	1520	72	17	1.4	4.3	7.7	0.08	0.08	125/2
OPP2 160	1490	2680	138	50	2.6	7.5	13.6	0.10	0.10	160/3.3
OPP2 180	1560	2800	250	107	4.4	8	14.2	0.16	0.16	180/4.3
OPP2 200	2200	3950	400	187	6.2	11.2	20	0.30	0.30	200/6.4
OPP2 250	3650	6150	820	596	12.4	18.6	31.3	0.60	0.60	250/8.7
OPP2 320	4860	8410	1200	1463	19	24.7	42.8	0.85	0.85	320/11.8

Transportable weight calculated with $\mu = 0.1$ and $f_s = 2$. With form-fit gripping the mass may be greater. The gripping force is the arithmetic sum of the individual finger forces at the fingers at "l" mm distance at 6 bar finger weight in Kg.

Empfehlung für max. Werkstückgewicht gerechnet mit $\mu = 0.1$ $f_s = 2$. Bei Formschluss sind größere Massen möglich. Die Greifkraft ist die arithmetische Summe der an den Greifbacken auftretenden Einzelkräfte im Abstand "l" in mm bei 6 bar. Eigenmasse in Kg.

2-finger parallel gripper - pneumatic - series OPP2 2-Finger - Parallelgreifer pneumatisch - Typ OPP2

Allowed load data

Maximal zul. Kräfte und Momente

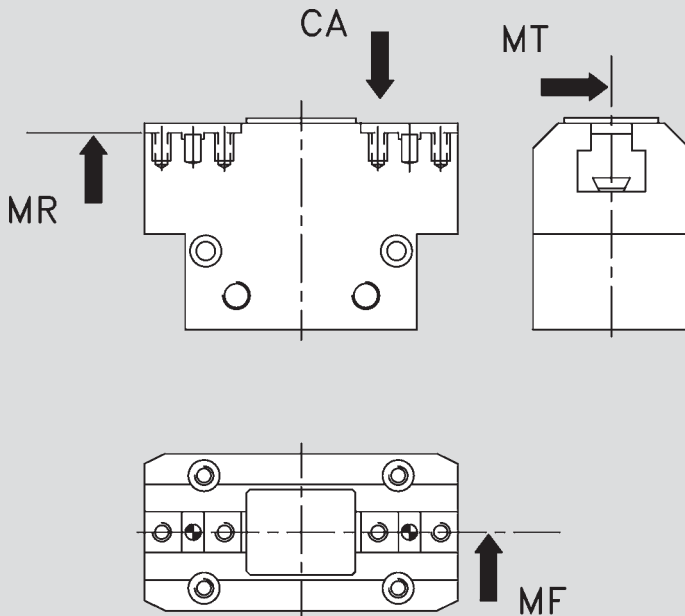

Type	CA (N)	MR (Nm)	MF (Nm)	MT (Nm)
OPP2 64	480	35	30	15
OPP2 80	620	85	35	35
OPP2 100	810	95	50	45
OPP2 125	930	100	70	65
OPP2 160	1140	110	85	85
OPP2 180	2200	115	90	95
OPP2 200	3200	140	100	120
OPP2 250	4300	200	135	170
OPP2 320	6600	330	250	280

Spring packaged pressure plate - code P

Federnder Andrückstern P

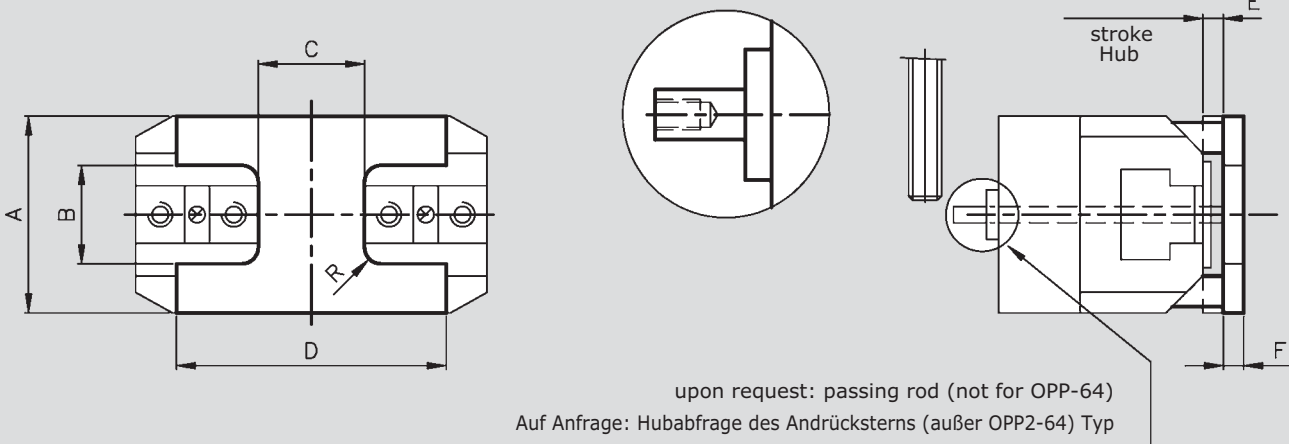

Type	OPP2								
Typ	64	80	100	125	160	180	200	250	320
A	38	44	52	62	74	80	90	120	144
B	16	22	26	32	42	44	48	60	80
C	20	24	26	38	48	60	66	88	116
D	53	62	80	98	120	140	154	196	240
E	4	4	5	6	6	8	8	10	10
F	5	6	7	8	8	9	9	12	14
R	3	4	4	5	5	6	6	8	10
Thrust Kraft	11-30N	38-45N	50-80N	100-240N	165-410N	210-380N	250-330N	380-510N	420-620N

NOTE : the grippers with spring packaged pressure plate can be applied through the lower holes only
Anmerkung: Der Greifer mit federnden Andrückstern kann nur über den unteren Kolben abgefragt werden

2-finger parallel gripper - pneumatic - series OPP2 2-Finger - Parallelgreifer pneumatisch - Typ OPP2

Force at 6 bar in N at l mm

Greifkraft (N) in Abhängigkeit der Fingerlänge "l" (mm) bei 6 bar

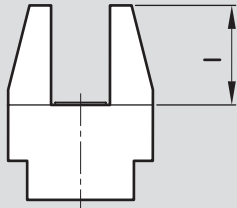

- code 1 closing Version 1 Außenspannen
- code 2 closing Version 2 Außenspannen

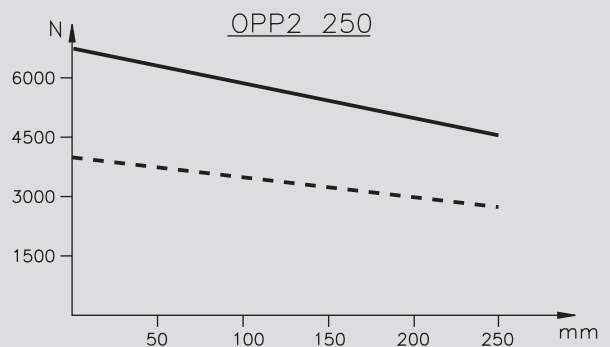
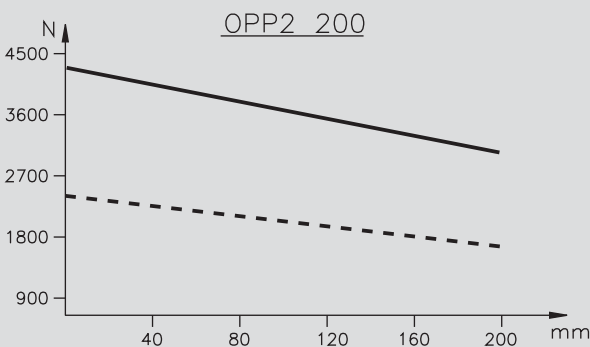
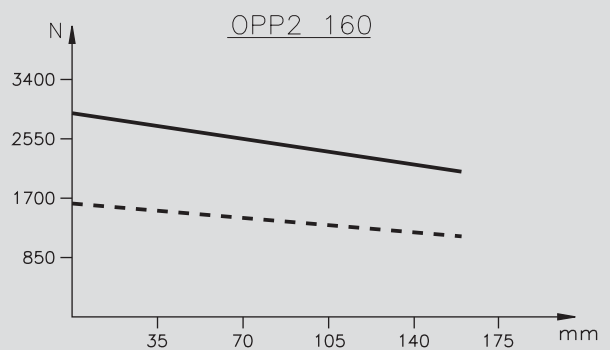
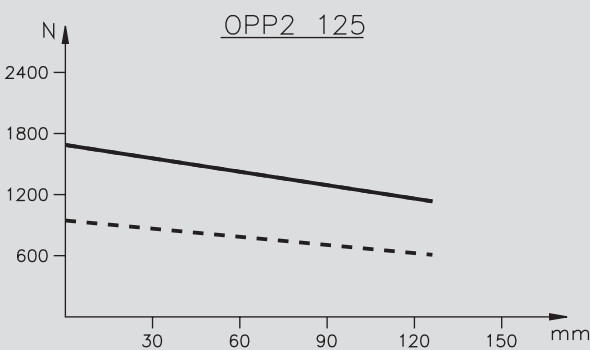
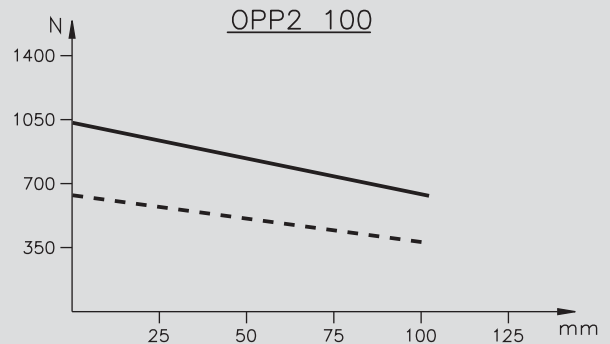
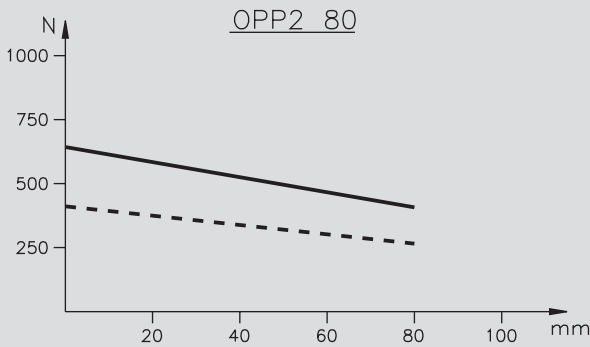
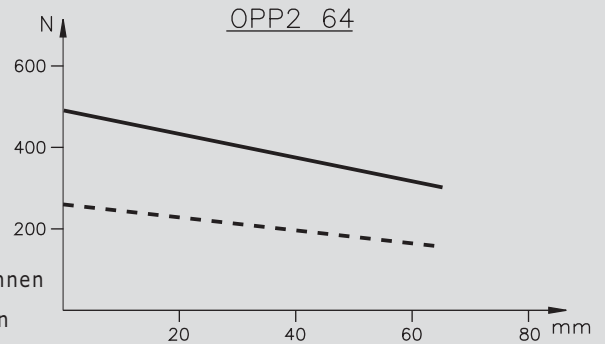

2-finger parallel gripper - pneumatic - series OPP2 2-Finger - Parallelgreifer pneumatisch - Typ OPP2

Safety device to preserve gripping force
code MC (closing) MA (opening)

Maßangaben für Greifer mit Greifkraftsicherung
Version MC (schließen) MA (öffnen)

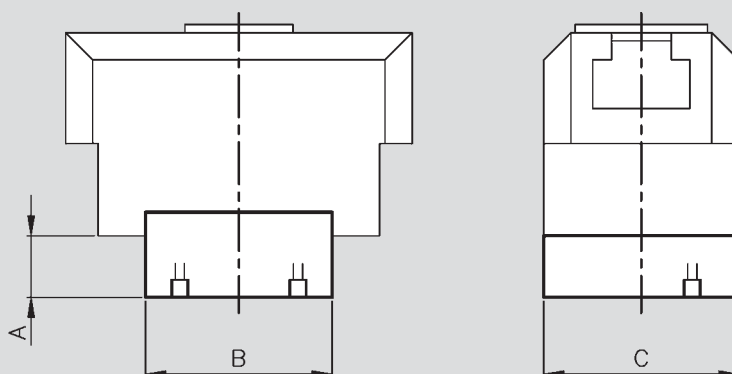

Type	A	B	C	Mass (Kg)	Gripping force (N) only with spring with fixed elasticity				Approx gripping time only with spring (s)
					code 1		code 2		
Typ	A	B	C	Masse (Kg)	Schließkraft über Feder in (N) beim Außenspannen				Schließzeit nur über Feder (s)
					Vers. 1		Vers. 2		
OPP2 64	14	35	38	0.33	80	180	150	300	0.035
OPP2 80	18	45	44	0.6	150	330	260	440	0.035
OPP2 100	21	54	52	1.1	200	420	350	660	0.06
OPP2 125	26	68	62	1.8	320	700	630	1300	0.18
OPP2 160	30	84	74	3.3	520	1100	1050	1750	0.23
OPP2 180	32	92	80	5	600	1100	1100	1900	0.34
OPP2 200	39	110	90	7.5	680	1300	1200	2300	0.5
OPP2 250	45	140	120	14.5	1100	2000	2300	4300	1.2
OPP2 320	60	160	144	21.5	1500	2500	3600	6500	1.6

NOTE: Minimum operating pressure 4.5 bar. Upon request versions with lower operating pressure; in this case the force of the spring will be less.

Gripping force = Pneumatic gripping force + spring gripping force.

Gripping force is the arithmetic sum of the individual forces of the fingers.

BEMERKUNG: Betriebsdruck mindestens 4.5 bar

Die Greifkraft ergibt sich aus der pneumatischen Greifkraft + Federkraft

Die Greifkraft ist die arithmetische Summe der an den Greifbacken auftretenden Einzelkräfte im Abstand "l" bei 6 bar

Ordering example

Type	Code 1 or 2	For internal bushes indicate B + level	For spring packaged pressure plate	For safety device indicate MC or MA	For passing rod indicate C
Typ	Version 1 oder 2	Für Ausführung mit Nahrungsschalter B+Durchmesser	Für federnden Andrückstern P	Für federgestützte Greifkraftsicherung MC oder MA	Für Hubabfrage des Andrückstern C
OPP2 100	C1	B8	P	MC	/

Bestellbeispiel

2-finger parallel gripper - pneumatic - series OPP2 2-Finger - Parallelgreifer pneumatisch - Typ OPP2

Maximum permitted finger offset

Diagramm der empfohlenen Hebel und Fingerlängen

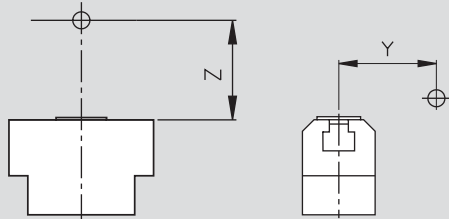

Z max: max length of the fingers with terminals inside the dimensions of the housing
Z max: Maximale Länge der Finger mit klemmen innerhalb der Dimensionen des Gehäuses

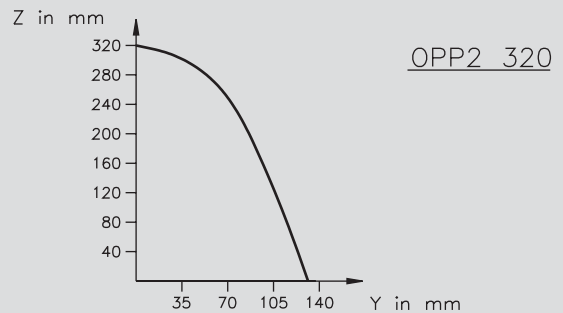
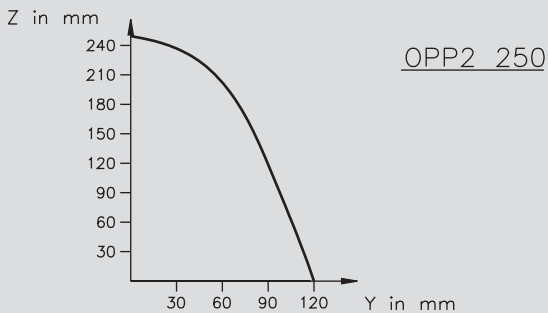
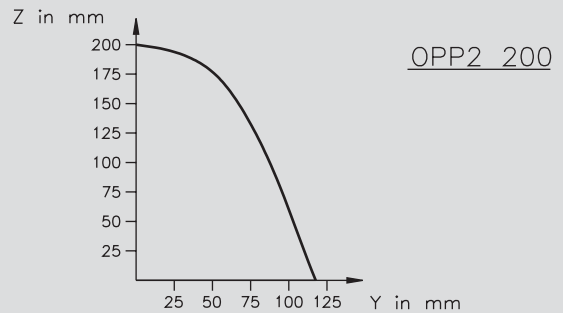
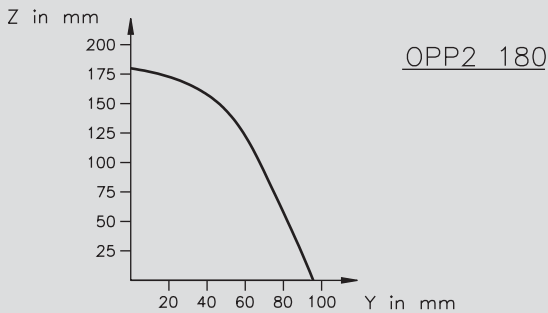
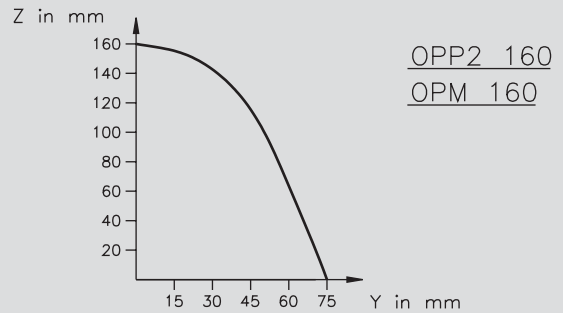
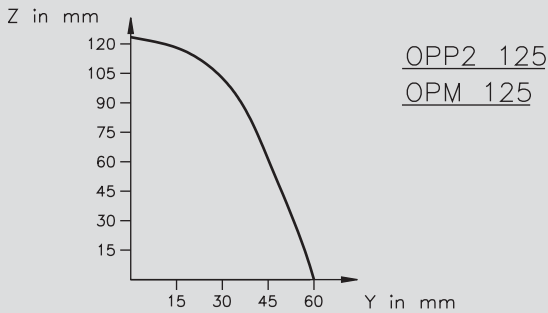
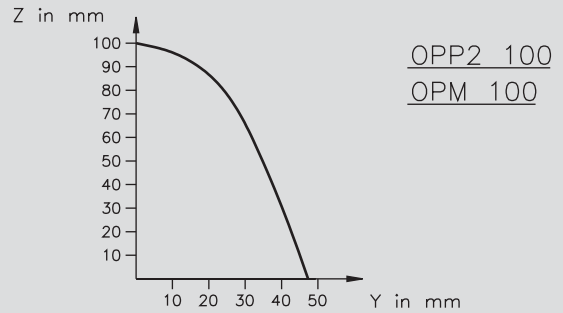
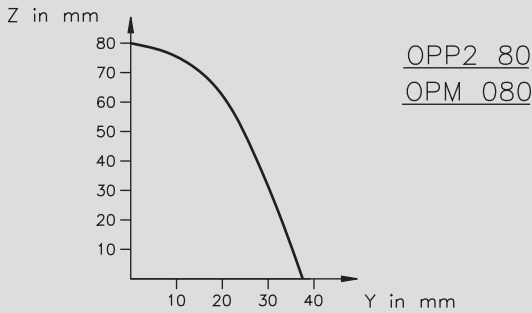
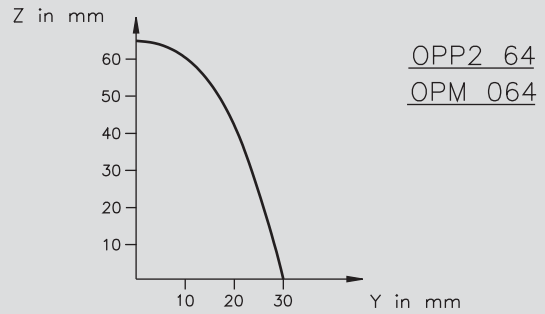

2-finger parallel gripper - pneumatic - series OPP2 2-Finger - Parallelgreifer pneumatisch - Typ OPP2

Dimensions of the finger for a appropriate connection

Anschlussmaße der Grundbacken

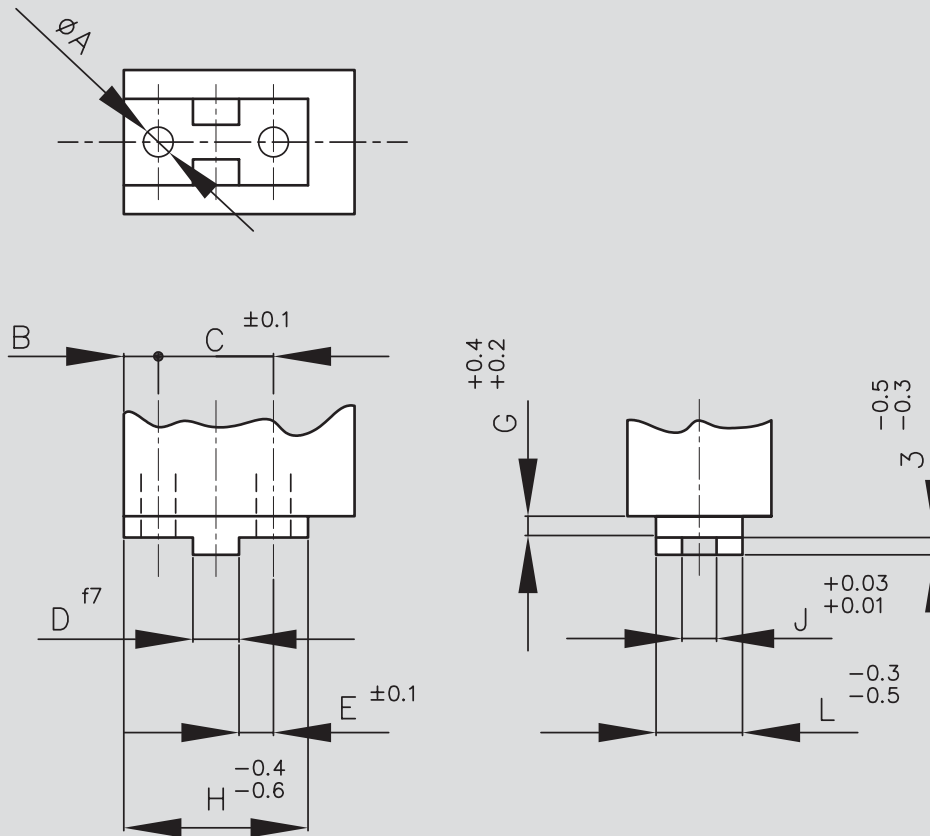

Type / Typ	A	B	C	D	E	G	H	J	L
OPP2-64/OPM- 064/MAC3-64/MFB-85/MA4-75/MIA1- G2-20	4.5	4	13	5	4	5	21	4	11
OPP2-80/OPM - 080/MAC3-80/MFB-110/MA4-95/MIA1- G2-25	5.5	5	16	6	5	7	25.5	5	13
OPP2-100/OPM - 100/MAC3-100/MFB-140/MA4-110/MIA1- G2-32	6.5	6	20	8	6	8	32	6	15
OPP2-125/OPM - 125/MAC3-125/MFB-170/MA4-145/MIA1- G2-40	8.5	8.5	24	8	8	9	40.5	6	18
OPP2-160/OPM - 160/MAC3-160/MFB-220/MA4-185/MIA1- G2-50	10.5	9	32	10	11	10	50	8	22
OPP2-180/MIA1 - G2-54	10.5	9.5	36	12	12	10	55	10	26
OPP2-200/MAC3 -200/MA4-230/MIA1- G2-60	12.5	11	40	14	13	10	62	12	30
OPP2-250/MAC3 -250/MA4-250/MIA1- G2-80	12.5	17	48	16	16	13	80	12	36
OPP2-320/MIA1 - G2-100	16.5	18	64	20	22	13	100	16	44